

User Manual

Model: Breezy Blue Response (SKU: BBR01)

With Bluetooth® Wireless Technology



Manufacturer and Contact Information

Manufacturer: Build With Robots

Address: 429 Commercial Street NE
Albuquerque, NM 87102

For product information, sales, service, and technical support:

<https://buildwithrobots.com/>

Customer Support Phone: (833) 273-3991

Email: info@buildwithrobots.com

This manual covers model: Breezy Blue Response (BBR01)

SPECIFICATIONS:

Voltage: 110-120 VAC

Watts: 1080 W



Amps: 9.0 A

Hertz: 50-60 Hz



Safety Symbols

These symbols and terms may appear on the product and in this user manual:

	Refer to the user manual for warning information to avoid hazard or personal injury and prevent damage to device.
	Alternating current (AC)
CAUTION	CAUTION indicates an imminently hazardous situation which, if not avoided, may result in minor or moderate injury, or product damage.
WARNING	WARNING indicates a hazardous situation which, if not avoided, could result in death or serious injury.



General Safety Summary

Review the following safety precautions to avoid injury and prevent damage to this product.

To avoid potential hazards or harm, use this product only as specified.

Failure to comply with the precautions and warnings in this manual violates the safety standards of the design, and the intended use of the product. The manufacturer assumes no liability for harm of persons or damage of property due to the customer's failure to comply with these requirements as the protection provided by the product may be impaired.

To avoid fire or personal injury:

Use proper power cord. Use only the power cord specified for this product and certified for the country of use.

Do not use the provided power cord for other products.

Ground the product. This product is grounded through the grounding conductor of the power cord. To avoid electric shock, the grounding conductor must be connected to earth ground.

Do not disable the power cord grounding connection.

Observe all ratings. To avoid fire or shock hazard, observe all ratings and markings on the product.

Power disconnect. The power cord disconnects the product from the power source. See Product Overview for the location. Do not position equipment so that it is difficult to disconnect the power cord; it must always remain accessible to the user to allow for quick disconnection if needed.



Do not operate without covers. Do not operate this product with covers or panels removed.

Avoid exposed circuitry. Do not touch exposed connections and components when power is present.

Do not operate with suspected failures. If you suspect that there is damage to this product, have it inspected by qualified service personnel.

Disable the product if it is damaged. Do not use the product if it is damaged or operates incorrectly. If there is doubt about the safety of the product, turn it off and disconnect the power cord. Clearly mark the product to prevent its further operation.

Examine the exterior of the product before use. Look for cracks or missing pieces.

Do not operate in wet/damp conditions.

Do not operate in an explosive atmosphere.

Do not operate while moving. Breezy Blue is intended to be operated in a stationary, level position.

Provide a safe working environment. Always place the product in a location convenient for viewing the button or waist-light status indicators.

Place the product where it would not be easily overturned.

Use care when lifting and carrying the product. This product is provided with a handle for lifting and carrying.



Use only BWR-approved solution in the product. Read and understand all safety and operational documentation for solution. Consult the safety data sheet and follow the recommended safety precautions when handling the solution and fogging.

Stay clear of area being treated while in use. Keep the room, vehicle, or immediate area to be treated clear of people, animals, food, etc. while device is in use and the fog is settling.

Avoid excess sound exposure. The device can produce sound levels greater than 80dBA while fogging. Be sure to wear appropriate hearing protection as needed and fog areas when there are no people present.

Keep product surfaces clean and dry.

Provide proper ventilation. To ensure the product functions as intended, keep the rear of device clear of obstructions.



Environmental Considerations

This section provides information about the environmental impact of the product.

Product End-of-Life Handling

Observe the following guidelines when recycling an instrument or component:

Equipment recycling. Production of this device required the extraction and use of natural resources. The device may contain substances that could be harmful to the environment or human health if improperly handled at the product's end of life. To avoid the release of such substances into the environment and to reduce the use of natural resources, we encourage you to recycle this product in an appropriate system that will ensure that most of the materials are reused or recycled appropriately. It is recommended that this device be taken to a certified Waste Electronic and Electrical Equipment recycler.

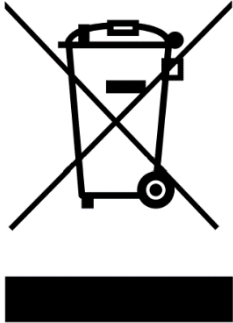

Do not throw in trash at end of product life.



Contents

Manufacturer and Contact Information	2
Safety Symbols	3
General Safety Summary	4
Environmental Considerations	7
Preface.....	10
Where to find more information.....	10
General Information.....	11
Service Information	12
Before Unpacking.....	12
Contents Included:.....	12
Getting Started.....	14
Operating Requirements	14
Cleaning.....	15
Powering the Device ON and OFF	16
Functions and Operating Descriptions	17
Default Factory Settings	17
Push Button Operation.....	17
BB01-WC Smart Controller Setup (Not included with Breezy Blue Response)	19
Approved BWR Solutions.....	20
Fill Port Instructions.....	20
Filling the Solution Tank from Empty	20
Filling the Solution Tank When Solution Level is Low	21
Emptying the Solution Tank.....	21
Troubleshooting.....	22
Maintenance.....	23
LIMITED WARRANTY (USA/CANADA).....	24

Keep this user manual in a readily accessible location



List of Figures

Figure 1: Overview of Breezy Blue Response device. Top/side view (left) and bottom view (right)..... 13

Figure 2: Power Breezy Blue Response on and off (electrical inputs)..... 16

List of Tables

Table 1: General features for Breezy Blue Response 11

Table 2: Environmental Specifications for Breezy Blue Response 14

Table 3: Power Specifications for Breezy Blue Response 15

Table 4: States and Status Indicators for Breezy Blue Response 18

Table 5: Breezy Blue Troubleshooting..... 22

Table 6: Breezy Blue Scheduled Maintenance 23



Preface

This manual describes the setup and operation of Build With Robots automated fogging technology. The following device is supported by this manual:

Breezy Blue Response

Where to find more information

Item	Purpose	Location
Safety and Compliance Instructions	Safety, Compliance, and Basic Startup	Printed Copy in Box https://buildwithrobots.com/support
User Manual	Unpacking, Installation, Settings, and Operation	https://buildwithrobots.com/support



General Information

The Build With Robots Breezy Blue™ Response is a self-contained, portable, and remote controlled cold fog dispensing system. Compatible with Build With Robots approved solutions, Breezy Blue Response can eliminate dangerous pathogens and organisms. Breezy Blue also collects and presents data to assure that your space has been thoroughly and properly treated.

Table 1: General features for Breezy Blue Response

Item	Specification
SKU	BBR01
Approved BWR Solutions	Breezy BioCare RTU™, Breezy BioPure RTU™*
Settling time	10 minutes (see solution instructions)
Tank capacity	4.7 L (1.25 gal)
Particle Diameter	20 um to 100 um
Fogger	Atomizing Cold fogger, 20 µm to 100 µm particles
Language	English
Connectivity	Bluetooth® Low Energy v5.2
Remote controller (up to 100 ft.)	Breezy Smart Controller (BB01-WC, sold separately)
Remote configuration	Status, Fogging Duration, Countdown Duration, Scheduling, Fluid Level, Alias
Visual indicators	Idle, Fog Countdown, Fogging, Fog Settling, Disabled
Audible indicator	Fog Countdown
Safety Feature	Fogger disable switch
User controls (via push button)	Delayed Turn-On or Immediate Off
AC power	110-120VAC / 50-60 Hz, 9.0A (while fogging)
Size and Weight	Diameter - 31.8 cm (12.5 in), Height - 41.9 cm (16.5 in), Weight - 10.9kg (24 lbs.) full of fluid
Portability	Handle for carrying and cord wrap

*Breezy BioPure RTU is not EPA registered for disinfection



Service Information

The product contains no serviceable parts and should not be disassembled, repaired, or modified by anyone other than the manufacturer or approved technicians.

Before Unpacking

Inspect the package carton for external damage. If the carton is damaged, notify the carrier.

Remove the device from its package and check that it has not been damaged in transit. Verify that the carton contains the device and contents listed below.

Contents Included:

- **1 x Safety and Compliance Instructions (printed)**
- **1 x AC power cord**
- **1 x Breezy Blue Response**

The appearance or components of the product may differ depending on the model. If anything is missing, please contact Build With Robots.



Product Overview

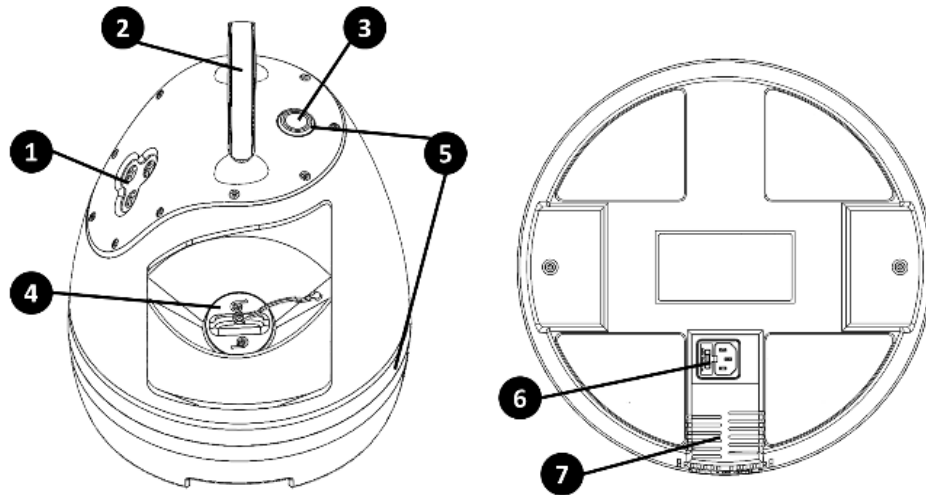

Figure 1: Overview of Breezy Blue Response device. Top/side view (left) and bottom view (right).

1. Fog outlet
2. Handle
3. Fogger enable/disable button
4. Fill port cap
5. Status lights (waist and button)
6. Power connector
7. Air intake



Getting Started

Operating Requirements

Install the device in a location meeting the following guidelines:

- Rear clearance: 5 cm (2 inches) or greater
- Recommended Height from ceiling: 1.2 m (4 feet) or greater
- Place device on a solid, level surface or cart
- Device is not meant to be operated while moving
- Install equipment so that power cord is easily accessible
- Do not place a unit near any motion or fire sensors. It is possible that the fog can set off these alarms.

Table 2: Environmental Specifications for Breezy Blue Response

Product Specification	Description
SKU	BBR01
Electrical Phase	Single
Installation Location	Indoor
Temperature	Operating: 5 °C to 40 °C Storage: 5 °C to 60 °C
Humidity	Operating: ≤ 80% RH: 31 °C Storage: ≤ 80% RH: 31 °C
Altitude	Operating: ≤ 3000 m (9,843 ft) Storage: ≤ 12,000 m (39,370 ft)
Flow Rate	About 13.6 L (3.6 gal) per hour of fogging
Fuse Rating	AC250V, 10A, slow blow
Sound	Up to 116dBA while fogging

Specifications are subject to change without notice.



Power Supply Requirements

WARNING. To reduce the risk of fire and shock, ensure that the main supply voltage fluctuations don't exceed 10% of the operating voltage range.

Table 3: Power Specifications for Breezy Blue Response

AC Input	110-120 VAC (+/- 10%), CAT II
Frequency	50/60Hz (+/- 5%)
Power	1080 W

WARNING. This product is grounded through the grounding conductor of the power cord. To avoid electric shock, the grounding conductor must be connected to earth ground.

WARNING. Do not disable the power cord grounding connection. Without the safety ground connection, all accessible conductive parts may provide an electric shock. Failure to use a properly grounded approved outlet and the included three-conductor AC line power cable may result in injury or death.

Cleaning

Inspect the device as often as operating conditions require. To clean the exterior surface, perform the following steps:

1. Unplug the device to power off.
2. Remove loose dust on the outside of the device with a lint free cloth.
3. Use a soft cloth dampened with water to clean the device. Use an aqueous solution of 70% isopropyl alcohol for more efficient cleaning.
4. Inspect the air intake slots and clean as needed using a vacuum or soft brush.



CAUTION. To avoid surface damage to the device, do not use any abrasive or chemical cleaning agents.

CAUTION. Avoid getting moisture inside the device during external cleaning. Use only enough water/cleaning solution to dampen the cloth or swab.

Powering the Device ON and OFF

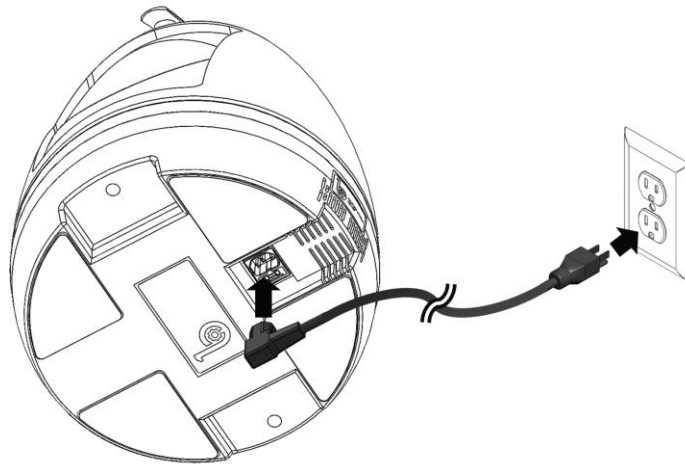

Figure 2: Power Breezy Blue Response on and off (electrical inputs)

The following instructions show how to apply power to the device and turn it on and off. Refer to Figure 1 and 2.

1. **Power On.** Connect the power cord to the underside of the unit and to an electrical outlet. The waist status light will turn either blue or yellow, indicating that the device is powered on.
2. **Power Off.** Disconnect the power cord from the underside of the unit or from the electrical outlet to power off.



Functions and Operating Descriptions

Below are the default settings and instructions for using the unit without the use of a Breezy Smart Controller (**sold separately**). The unit will provide the user visual and audio status using the mechanisms shown in Table 4. Also see *Fill Port Instructions – Filling the Solution Tank when Low* for more information.

Default Factory Settings

- Push-button mode: ENABLED
- Countdown duration: 20 seconds
- Fogging duration: 30 seconds
- Settling duration: 10 minutes
- Alias: serial number

Push Button Operation

(Refer to Figure 1.)

1. Depress the *fogger enable button* (if already depressed, press two times).
 - a. A 20 second countdown to fogging will begin, accompanied by flashing red *status lights* and an audible alert on Breezy Blue during which the area being treated must be cleared of all people, animals, etc.
 - b. A 30 second fogging will begin when the *status lights* turn solid red, and the fogger motor turns on.
 - c. After fogging is complete, the *lower status lights* will flash yellow to indicate the fog settling phase for 10 minutes.
 - d. After the settling is complete the *lower status light* will turn blue, and the area can be opened for fresh air circulation.



Table 4: States and Status Indicators for Breezy Blue Response

Status	LED Ring	Button LEDs	Audio	Status Icon	Breezy Controller Icon
Not currently seen by controller, but previously seen by controller	Any option below	Any Option below			
Idle + Enabled	Blue	Off		Ready to Fog	
Idle + Disabled	Yellow	Yellow		Disabled	
Fogging Countdown	Red, blinking	Red, blinking	[Beep] "Alert, disinfectant fogging will begin soon. Please leave the area or press the disable button."	Countdown	
Fogging	Red	Red		Fogging	
Fog Settling	Yellow, blinking	Off		Settling	
Firmware updating	White, then magenta	Off		Progress bar	
Error	Magenta, blinking	Off		Error	



BB01-WC Smart Controller Setup (Not included with Breezy Blue Response)

Breezy Smart Controller User manual can be found at:

<https://buildwithrobots.com/support>



Approved BWR Solutions

Safety and operational information, including fogging and fog settling times using BWR approved solutions, can be found at [Breezy Chemicals \(buildwithrobots.com\)](https://www.buildwithrobots.com) and [Breezy Products Support \(buildwithrobots.com\)](https://www.buildwithrobots.com)

Fill Port Instructions

Filling the Solution Tank from Empty

1. Unscrew the fill port cap.
2. Ensure the screen filter is in place and free of debris.



3. Pour up to 3.8L (1 gal) of Build With Robots approved solution into tank. Stop filling if solution level is visible in the screen filter. Do not overflow.
4. Replace the fill port cap.

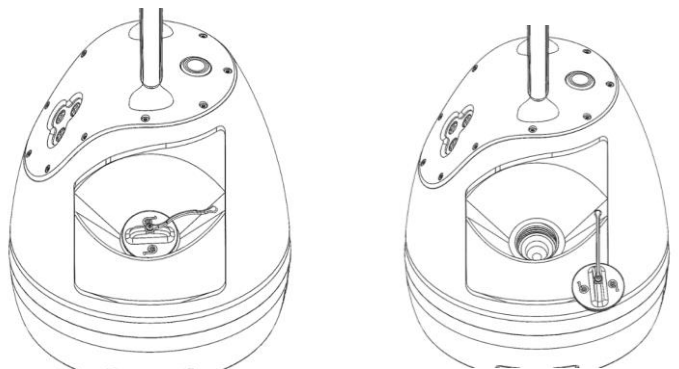

Filling the Solution Tank When Solution Level is Low

1. Unscrew the fill port cap.
2. Ensure screen filter is in place and free of debris
3. Slowly pour up to 3.8L (1 gal) of Build With Robots approved solution into tank until the tank icon on the controller shows the tank is full or if solution level is visible in the screen filter*. Do not overfill.

*Note - without the Breezy Smart Controller, the user will not be able to view the level of the solution in the tank. The user can temporarily remove the screen filter to visually check the fluid level in the tank. Be sure to replace the screen filter before filling the unit or replacing the fill port cap.

Emptying the Solution Tank

In the case that the solution in the tank needs to be emptied, power off the unit, remove the fill port cap and screen filter and tip the unit so the fill port is at the lowest elevation possible. Be sure to properly dispose of the solution removed from the tank (refer to solution SDS).



Troubleshooting

Table 5: Breezy Blue Troubleshooting

PROBLEM	POSSIBLE CAUSES	SOLUTION
Waist band light does not illuminate	Unit is not powered	Ensure unit is fully plugged in both at the power input module on the underside of the unit and at the outlet, and that the outlet is working
	Damaged fuse	Replace fuse in socket next to power cord
	Other	Unplug and re-plug in the unit
Fogger motor won't turn on when started from app, but lights are illuminated on unit	Fogger disable switch is in the up position (un-depressed)	Make sure switch is in the down (depressed) position
Fogger motor turns on, but fog does not come out	Solution level is too low	Refill solution
	Air intake ports are blocked	Ensure that air intake ports on rear and underside of unit are clean and clear of obstruction
Excessive moisture builds up on unit or surrounding area after fogging	Build-up or obstruction at the fogger intake or output ports	Clean air intake at rear of unit and all three fogger output ports with a damp cloth and remove any obstructions
Waistband Light Flashing Magenta	Fogger motor or Solenoid valves are not functioning properly	Clean air intake at rear of unit and all three fogger output ports with a damp cloth and remove any obstructions. Unplug device, wait 10 minutes, then re-power device.



Maintenance

Table 6: Breezy Blue Scheduled Maintenance

Part	Clean/Replace
Fill port screen filter	Remove and clean fill port screen filter every 10 gallons of solution or when contaminated using water and a soft brush
Exterior	Wipe down exterior of unit monthly using a cloth wetted with water or 70% isopropyl alcohol
Synchronize time	If using the scheduling feature, Synchronize Breezy Blue with the controller time every three months or as needed.
Firmware update	Check for and install firmware updates monthly using the Breezy Smart Controller



LIMITED WARRANTY (USA/CANADA)

Build With Robots warrants that this product will be free from defects in materials and workmanship for a period of one (1) year from the date of shipment. If any such product proves defective during this warranty period, Build With Robots, at its option, either will repair the defective product without charge for parts and labor, or will provide a replacement in exchange for the defective product. Parts, modules and replacement products used by Build With Robots for warranty work may be new or reconditioned to like new performance. All replaced parts, modules and products become the property of Build With Robots.

In order to obtain service under this warranty, Customer must notify Build With Robots of the defect before the expiration of the warranty period and make suitable arrangements for the performance of service. Customer shall be responsible for packaging and shipping the defective product to the service center designated by Build With Robots, with shipping charges prepaid. Build With Robots shall pay for the return of the product to Customer if the shipment is to a location within the country in which the Build With Robots service center is located. Customer shall be responsible for paying all shipping charges, duties, taxes, and any other charges for products returned to any other locations.

This warranty shall not apply to any defect, failure or damage caused by improper use or improper or inadequate maintenance and care. Build With Robots shall not be obligated to furnish service under this warranty a) to repair damage resulting from attempts by personnel other than Build With Robots representatives to install, repair or service the product; b) to repair damage resulting from improper use or connection to incompatible equipment; c) to repair any damage or malfunction caused by the use of non-Build With Robots supplies; or d) to service a product that has been modified or integrated with other products.

THIS WARRANTY IS GIVEN BY BUILD WITH ROBOTS WITH RESPECT TO THE PRODUCT IN LIEU OF ANY OTHER WARRANTIES, EXPRESS OR IMPLIED. BUILD WITH ROBOTS AND ITS VENDORS DISCLAIM ANY IMPLIED WARRANTIES OF MERCHANTABILITY OR FITNESS FOR A PARTICULAR PURPOSE. BUILD WITH ROBOTS' RESPONSIBILITY TO REPAIR OR REPLACE DEFECTIVE PRODUCTS IS THE SOLE AND EXCLUSIVE REMEDY PROVIDED TO THE CUSTOMER FOR BREACH OF THIS WARRANTY. BUILD WITH ROBOTS AND ITS VENDORS WILL NOT BE LIABLE FOR ANY INDIRECT, SPECIAL, INCIDENTAL, OR CONSEQUENTIAL DAMAGES IRRESPECTIVE OF WHETHER BUILD WITH ROBOTS OR THE VENDOR HAS ADVANCE NOTICE OF THE POSSIBILITY OF SUCH DAMAGES.

